



User guide





User guide



NORMALUX

by Normagrup

Index	Page
1. Introduction	1
2. Technical Data	1
3. C24-100M mounting.....	3
4. C24-300M mounting.....	5
5. Electrical connection	8
6. Main pannel	12
7. Functioning of the unit	13
8. Screens directory	15
9. MENU screen	17
10. INFO screen	18
11. CONTROLS screen	22
12. OPTIONS screen	23
13. SETTINGS screen	25
14. Distances and wire sections calculation	28
15. Index of failures	29
16. Index of warnings	30
17. Modbus integration	30

Spanish version



1. Introduction

C24 fittings allow to remotely supply power to 24Vdc luminaries. There are two models depending on the output power:

- C24-100M (100W)
- C24-300M (300W).

These are intelligent domotic devices which give warnings about possible anomalies both in the centrals themselves and / or in the lines where the emergency lighting is connected.

It is possible to control the centrals from a PC.

24Vdc permanent outputs available.

3 24 Vdc (50w max.) relay outputs controlled by BUS.

In this gued you will find detailed information about the C24 centrals and its configuration.

2. Technical data

- Voltage: 230 V AC +/- 10%.
- Wire section: 2,5 mm².
- Output voltage: 24 V DC +/- 20%.
- Outputs wire section: 2,5 mm².
- Working temperature: -5°C to 25°C.
- Class: I.
- IP30.
- Outputs: 4.
- Maximum current: 3,5 A on each output.
- Dimensions:
 - C24-100M: 340 x 330 x 90 mm.
 - C24-300M: 500 x 400 x 200 mm.
- Maximum permanent power: C24-100M(100W) C24-300M (300W).

Warning!. By regulation, after a complete battery discharge the central panel will show a warning on the led corresponding to the icon below. To switch off this warning, please access the "OPTIONS" menu and then select "OFF.BAT.DISCHARGED".

C24-100M

Batteries	2x12V · 7Ah			2x12V · 9Ah		
	1h	3h	8h	1h	3h	8h
Duration						
Maximum Power *	88W	36W	14W	115W	48W	19W
I max (A)	3,86	1,70	0,76	4,97	2,19	0,97
Input phase monitor	YES					
Output control	4					
Potential free contact relay	YES					
Functioning indicator	YES					
Battery functioning indicator	YES					
Fail	YES					
Power supply indicator	YES					
Battery supply indicator	YES					
Alarm / Fail indicator	YES					
Complete discharge indicator	YES					
Active output indicator	YES					
BUS communication	YES					

C24-300M

Batteries	2x12V · 12Ah			2x12V · 18Ah			2x12V · 24Ah		
	1h	3h	8h	1h	3h	8h	1h	3h	8h
Duration									
Maximum Power *	154W	66W	27W	234W	105W	42W	314W	136W	58W
I max (A)	6,62	2,92	1,30	9,94	4,39	1,95	13,25	5,85	2,60
Input phase monitor	YES								
Output control	4								
Potential free contact relay	YES								
Functioning indicator	YES								
Battery functioning indicator	YES								
Fail	YES								
Power supply indicator	YES								
Battery supply indicator	YES								
Alarm / Fail indicator	YES								
Complete discharge indicator	YES								
Active output indicator	YES								
BUS communication	YES								

* Maximum power to ensure autonomy in emergency mode (W).

3. C24-100M mounting

Step 1

Remove the 4 screws and open the front cover.

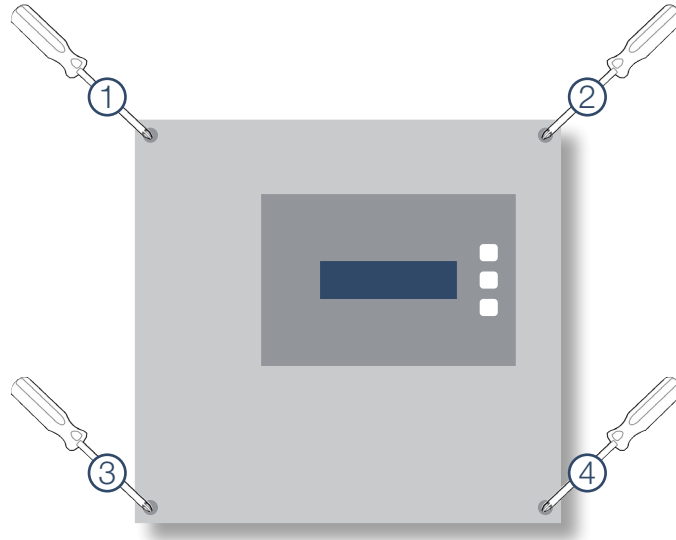

Step 2

Use the ring under the PCB to move the circuit. Break open the pre-cutted holes for the wiring.

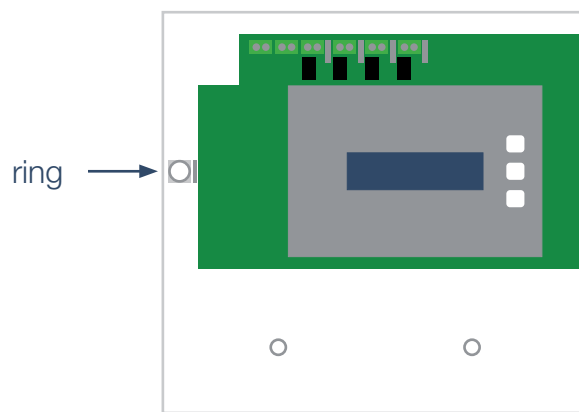

Step 3

Fix the fitting to the wall using the three holes in the housing.

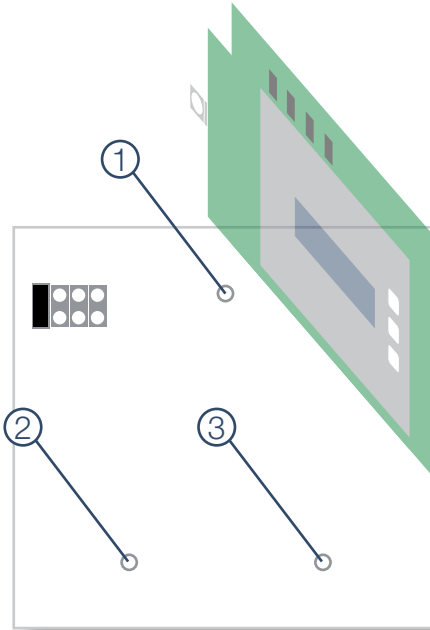

Step 4

Connect the fitting with 230 Vac y 50 Hz between L y N and the earth connection.

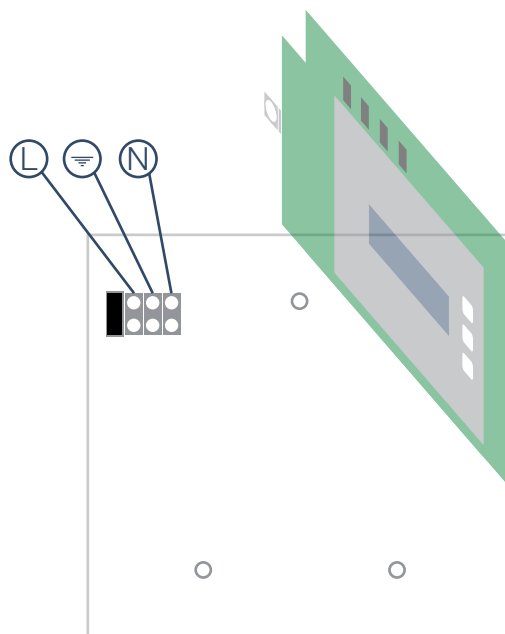

Step **5**

Place the two batteries in the lower part of the housing and connect them. Close the central.

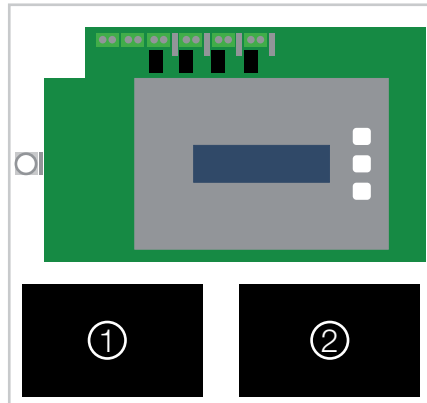

4. C24-300M mounting

Step **1**

Take out the screw and remove the frontal panel by pulling the cover up and then pulling the cover towards you.

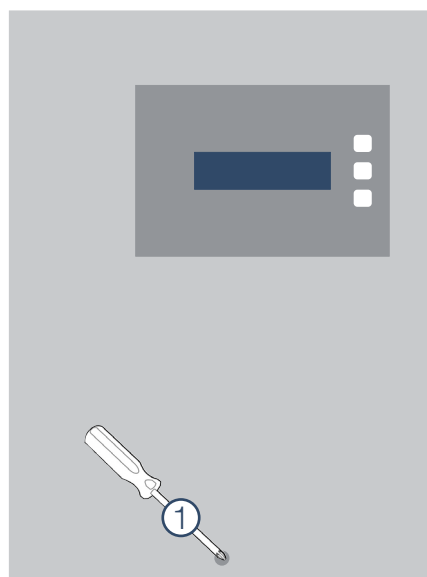

Step 2

Fix the back plate to the wall.

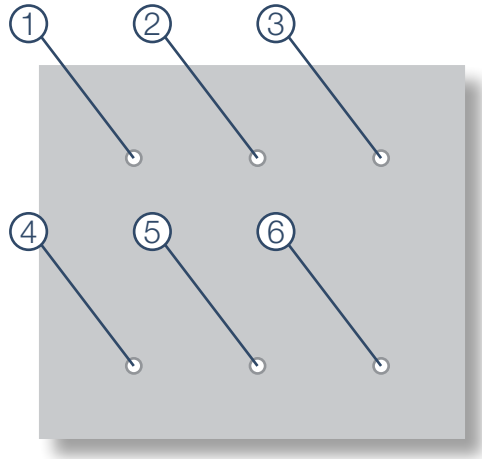

Step 3

Screw the housing of the central to the back plate that has been fixed to the wall and secure the screws firmly.

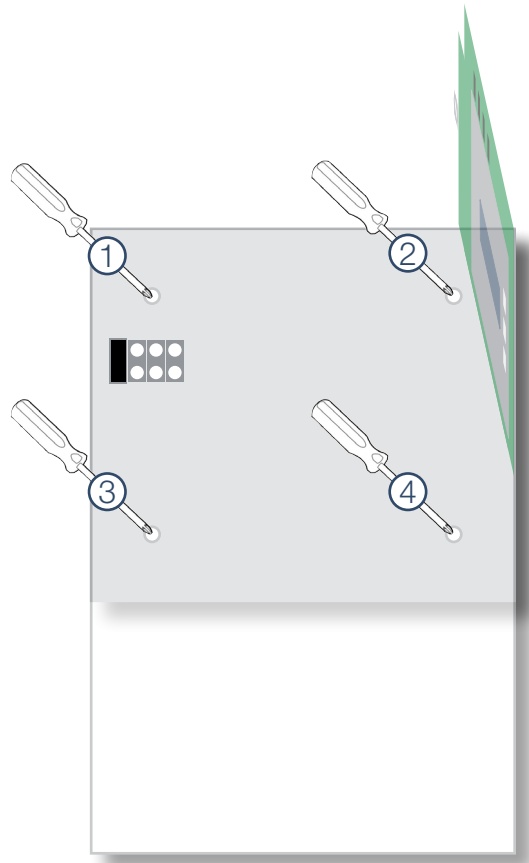

Step **4**

Connect the power supply to the 230Vac 50 Hz terminal block between L and N and the earth terminal. Make the wiring to the luminaires in each one of the available outputs (OUT) and in case that auxiliary inputs and outputs are needed (see drawings in the following pages). After this, please connect the batteries and place the cover of the central.

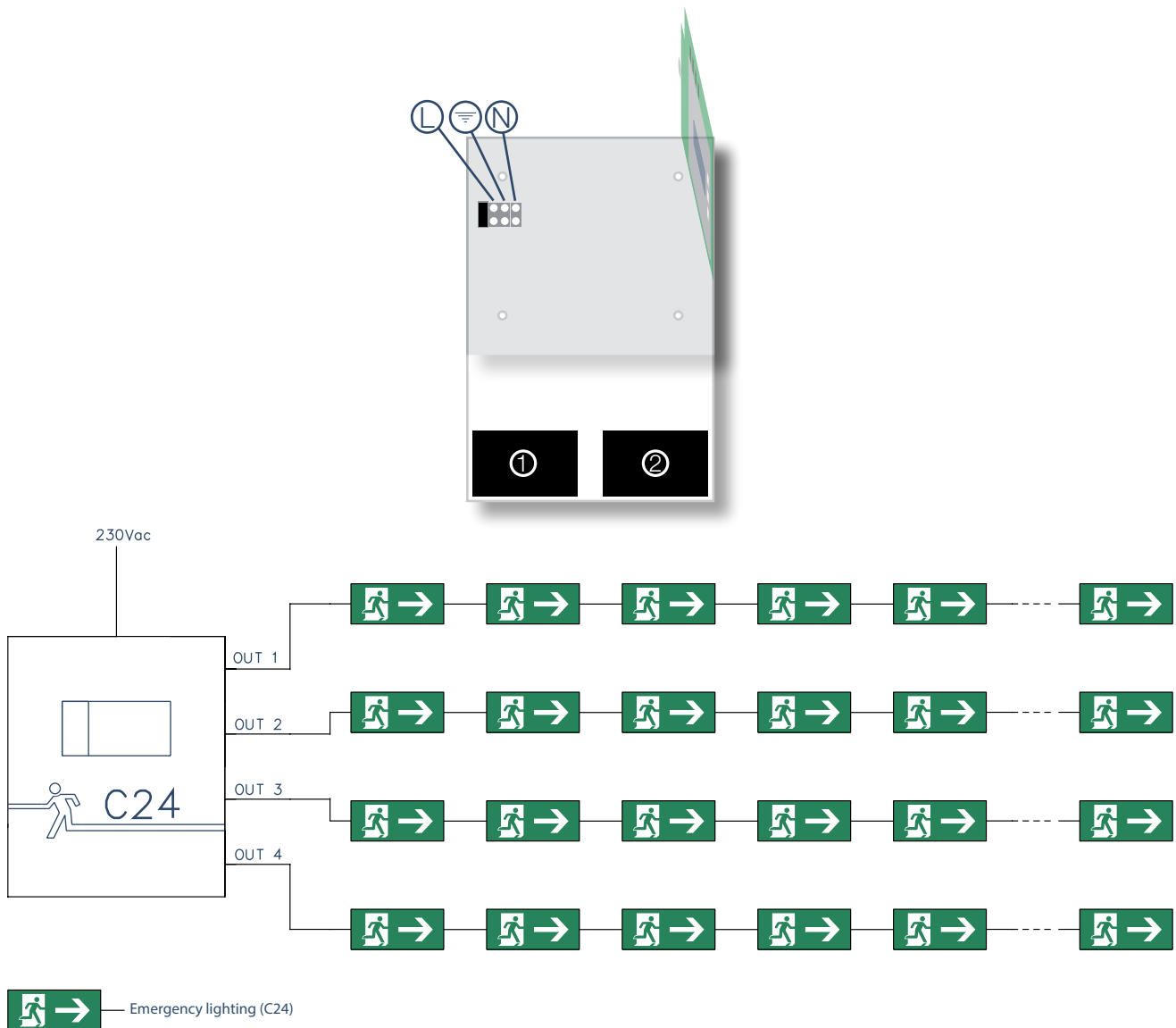

The maximum number of luminaires to be connected in a central can be calculated following the table on page 2, with a maximum power limit of 3.5A on each of the 4 outputs (although some countries establish a limit of 12 or 20 units per output). The power of each fitting is a feature of the fitting itself, so this must be checked in its technical datasheet.

The distance and cable section to be used in the outputs is calculated following the instructions on page 28.

5. Electrical connection

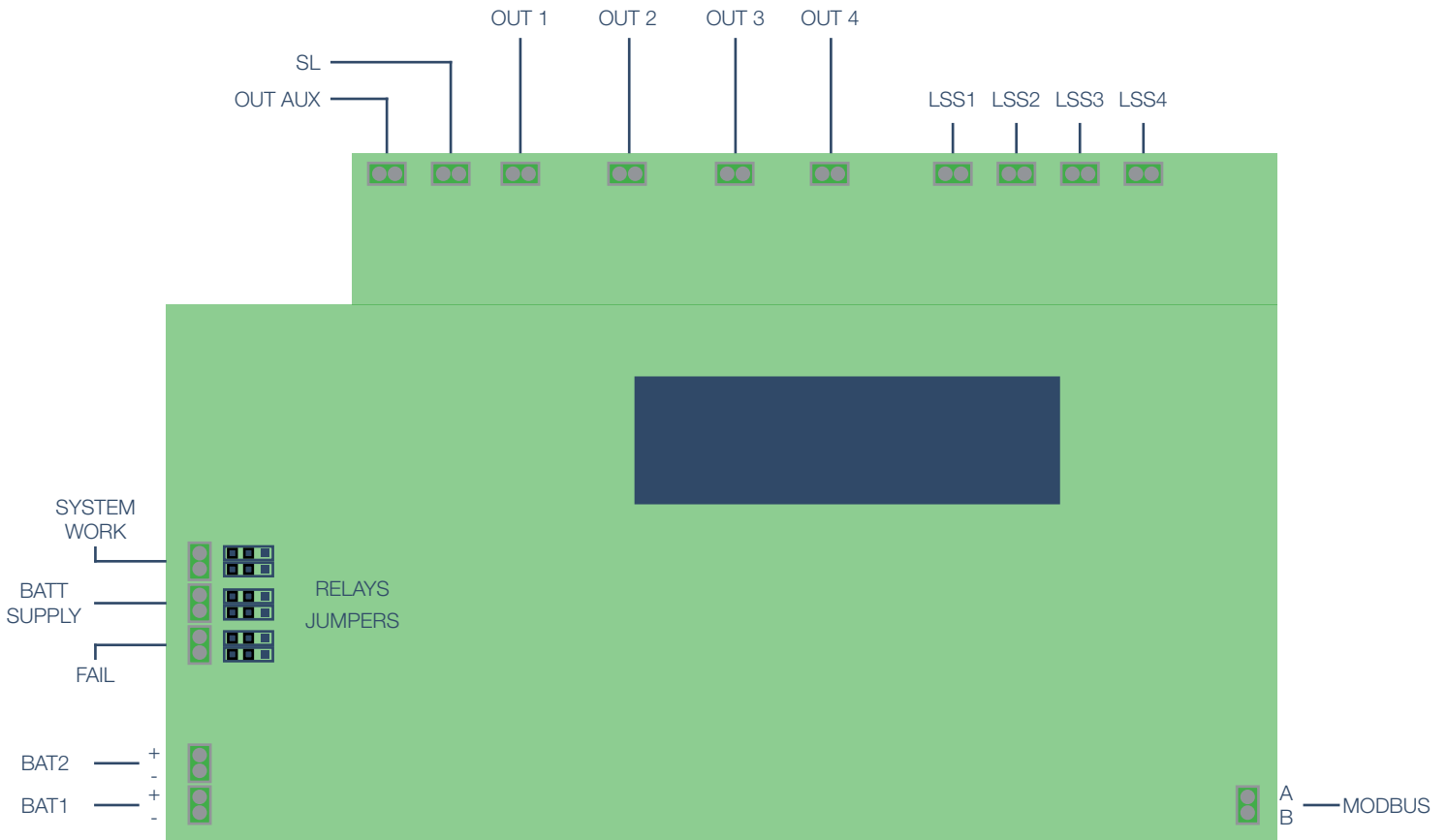

- SL (Sense Loop): Input to connect a phase monitor. If this is not connected it should remain jumpered.
- OUT AUX: Auxiliary output to interconnect centrals by means of the SL (Sense Loop) output.
- OUT 1: Output 1. 24v y 3,5A max. outputs, protected against short-circuit, by fuse and electronic cut. These outputs include an amperimeter (class <1.5). It is able to inform the controller about the exact amount of current in the mentioned output.
- OUT 2: Output 2. It also provides a small current (when the fitting is off) to turn a green LED installed in the luminaries on.
- OUT 3: Output 3.
- OUT 4: Output 4.

- LSS1 (Light Sequence Switching).
 - LSS2 (Light Sequence Switching).
 - LSS3 (Light Sequence Switching).
 - LSS4 (Light Sequence Switching).
- 230Vac · 50Hz inputs used for the control of the outputs.
- SYSTEM WORK: Potential free contact relay that indicates that the central is working correctly (normally open).*
 - BATTERY SUPPLY: Potential free contact relay that indicates that the central is working by means of the battery (normally open)*
 - FAIL: Potential free contact relay that indicates that there is a failure in the central (normally open).*
 - BAT1: Battery connection. The capacity depends on the model.
 - BAT2: Battery connection. The capacity depends on the model.
 - MODBUS: Connection for the domotic BUS.

* It is possible to configure all the functioning modes of all the potential free contact relays (SYSTEM, WORK, BATTERY SUPPLY and FAIL). Just modify the configuration of the jumpers as shown below:

- System mode.



- Auxiliar output mode.



Sense Loop (SL). Wiring scheme

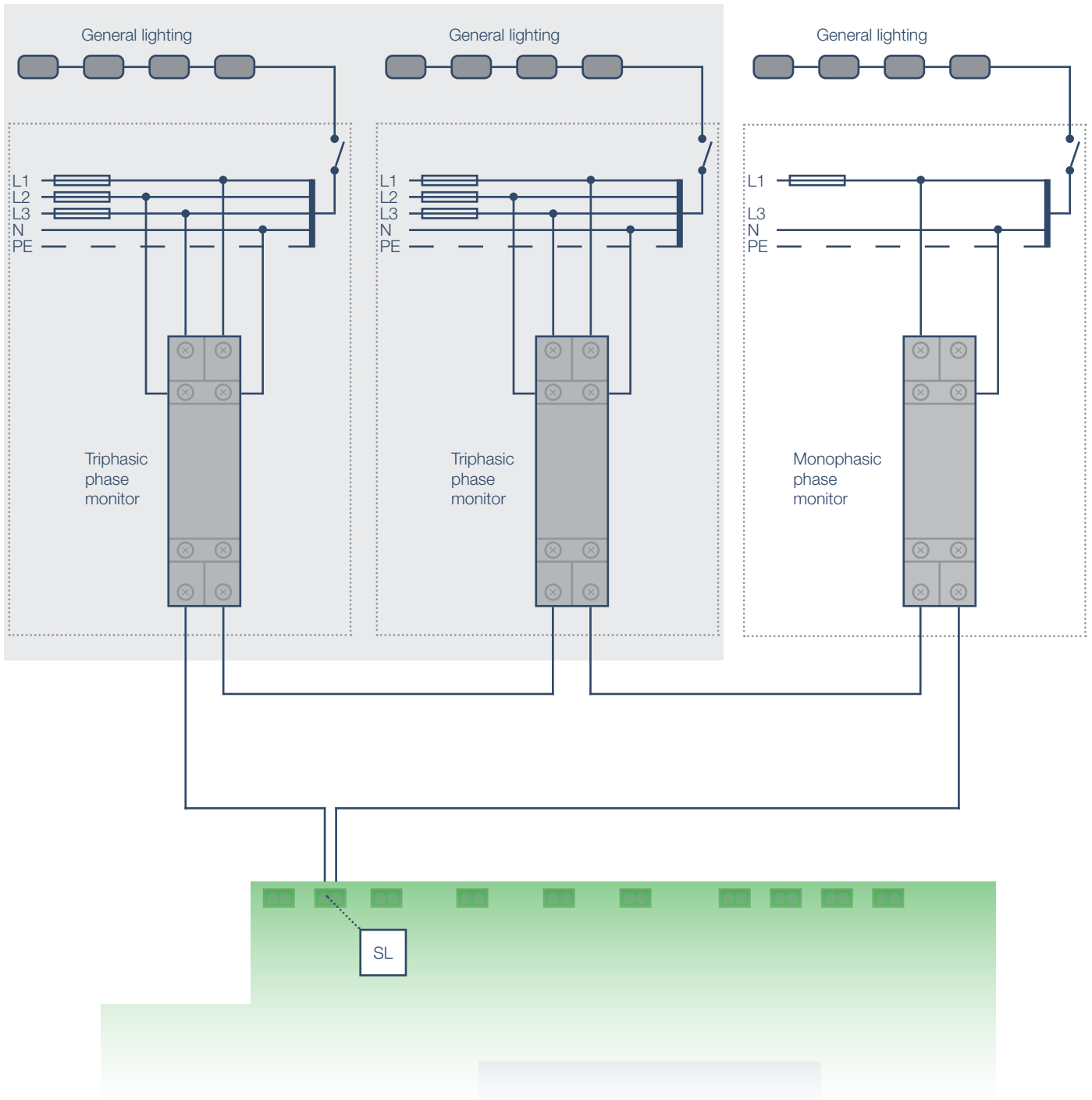

OUT AUX. Wiring scheme

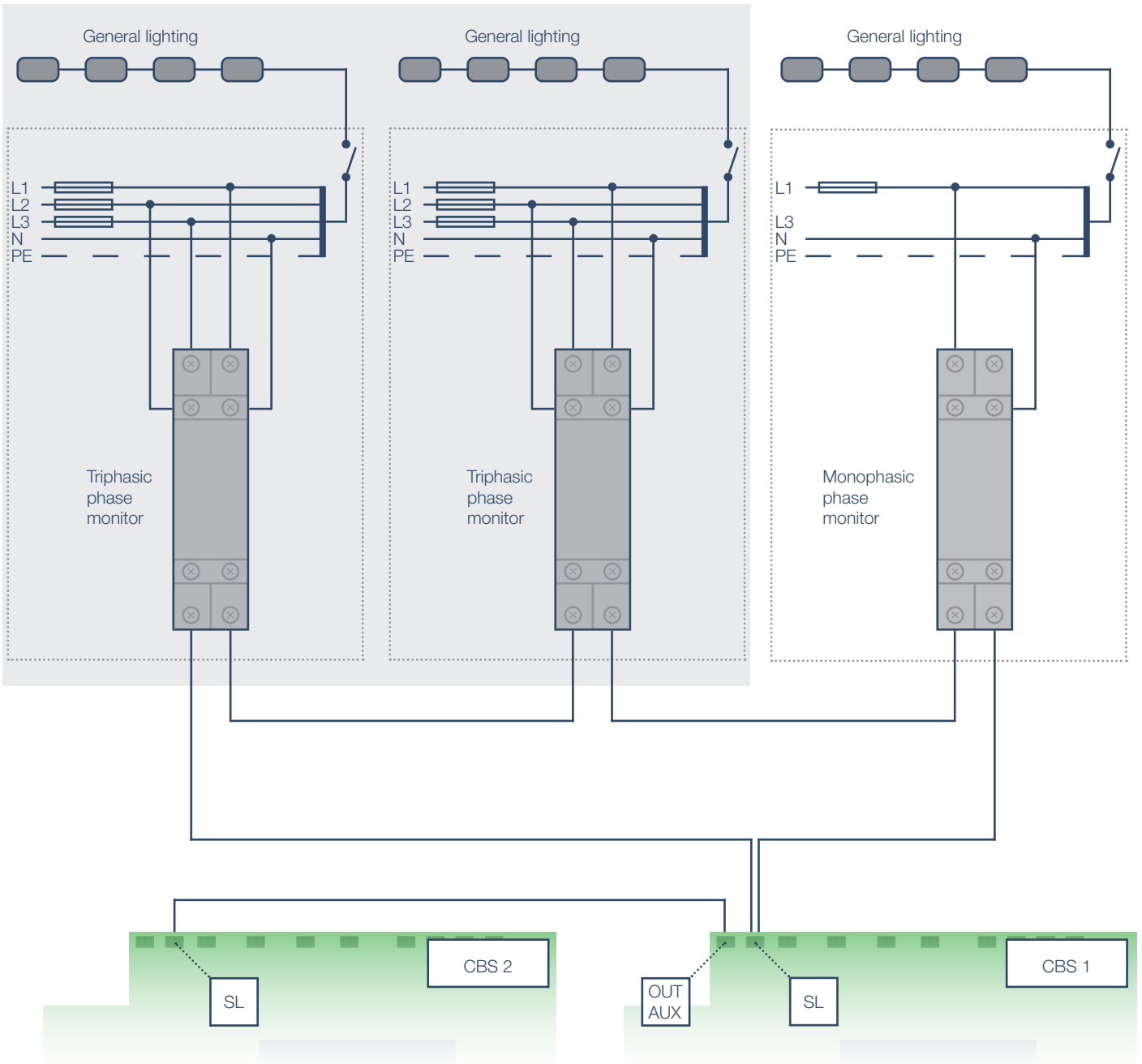

6. Front pannel

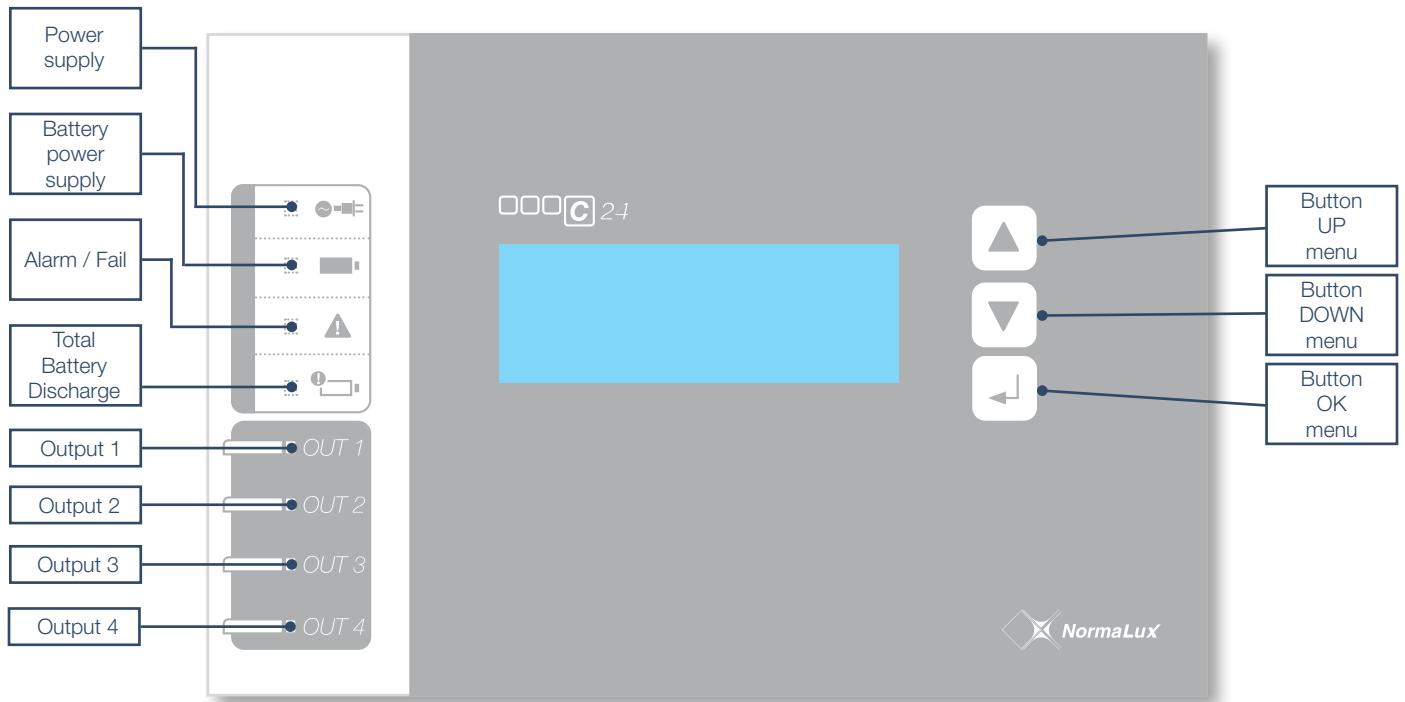

- Power supply: The LED on means the central is receiving power from the normal power supply.
- Battery power supply: The LED on means the central is receiving power from the batteries.
- Alarm / Failure: The LED on means the central has detected an alarm or failure.
- Total battery discharge: The LED on means the battery has been discharged totally. The indication should be re-armed.
- Output 1: The LED on means that output 1 is activated.
- Output 2: The LED on means that output 2 is activated.
- Output 3: The LED on means that output 3 is activated.
- Output 4: The LED on means that output 4 is activated.

7. Functioning of the central

Once the fitting has been connected to the power supply, the welcome screen will show up. Choose the language and choose if you want the configuration wizard to run. Once the wizard is finished, the main screen will show up.

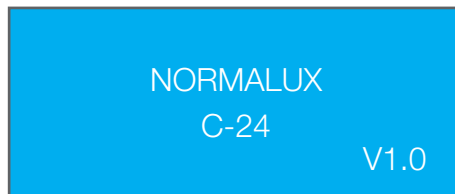

welcome screen

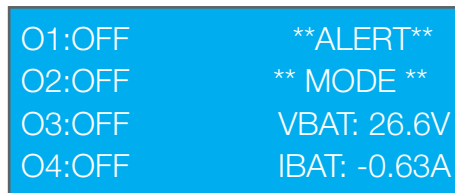

main screen

The main screen will show the status of the central, as well as the status of the 4 outputs.

The upper right part of the screen will inform about the current functioning mode of the central. There are five functioning modes available:

- **ALERT MODE:** The device is being fed by means of the internal power supply, awaiting any possible failure of the mains.
- **EMERG_EXT MODE:** The device will enter into EMERG_EXT mode when the SL (Sense Loop) output is open. All the other outputs will be activated until SL output has been restored. Also, the OUT AUX contact will be open, allowing other centrals interconnected between them by means of this output to go into EMERG_EXT mode as well.
- **EMERGENCY MODE:** The device will get into this mode if it detects a power supply failure from mains. The battery will then give power supply to all the outputs, which will also be activated.
- **REST MODE:** The device will enter into this mode when, once in EMERGENCY MODE the batteries are discharged to a point where it is not possible to provide power supply to the outputs. To avoid damaging the batteries, the central will cut the power supply provided from them, indicating that the batteries have reached a total discharge. The central will still be receiving the power from the batteries, but all the outputs will be off.

- **EQUAL MODE:** The central unit will enter into this mode when moving from resting mode into alert mode, and the battery has been fully discharged. In this mode, the central unit will try to equalize the capacity of both batteries. This way, when the batteries are charging, both of them will start charging from the same point. This process may take a few minutes.

Functioning logic.

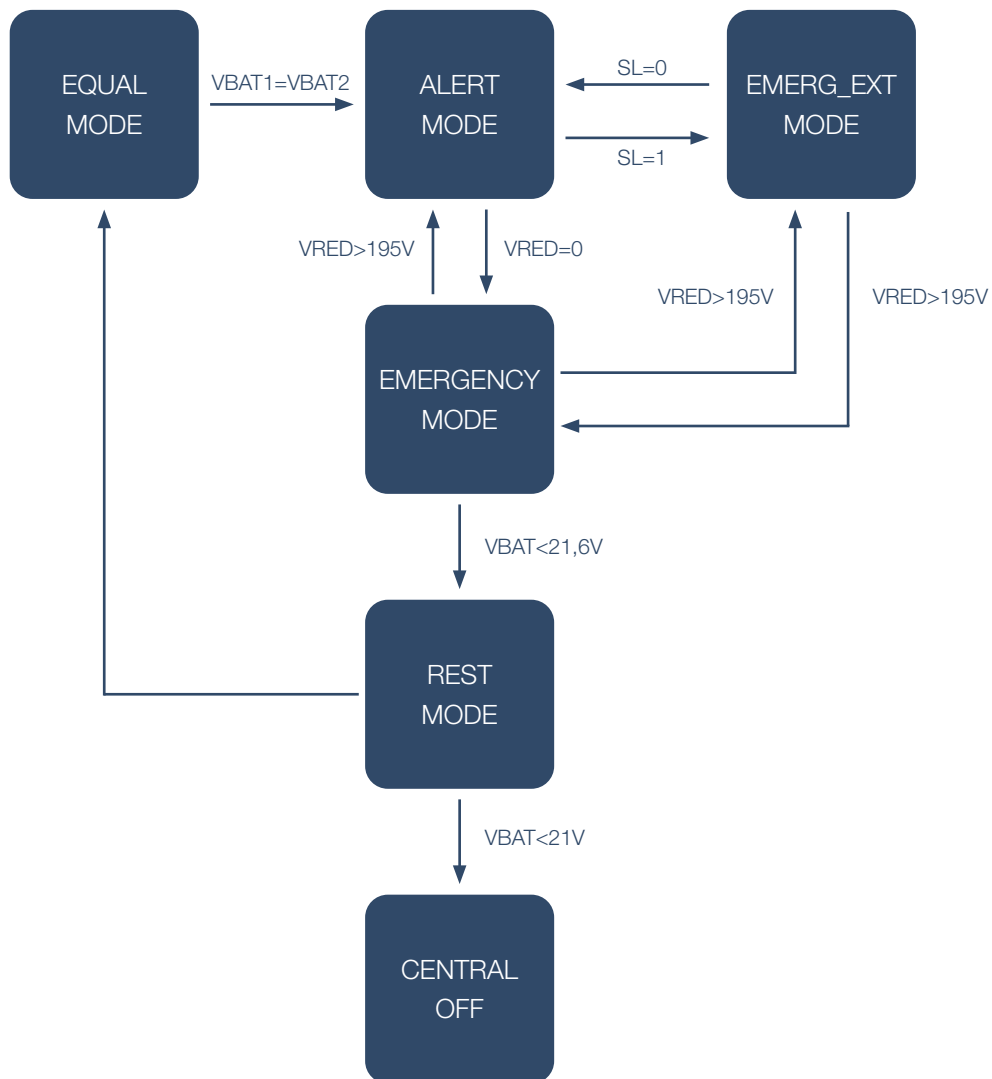

On the lower right side of the main screen, the actual value of current and voltage of the battery will be displayed.

On the left part of the screen, the status of each output will be displayed. The status could be:

- OFF: When the output remains deactivated.
- WARN: When the output voltage is lower than the minimum voltage programmed.
- WARN: When the output voltage is lower than the minimum voltage programmed.
- #VALUE: When the output is activated, but there is no failure, the current voltage output value will be displayed in amperes.

8. Screens directory

Using the up, down, left and right buttons (located in the right part) it is possible to browse through the different screens of the menu. These are the existing screen options:

1. WELCOME SCREEN

2. MAIN SCREEN

2.1. MENU

2.1.1. INFORMATION

2.1.1.1. FAILURES

2.1.1.2. OUTPUTS

2.1.1.2.1. OUT 1

2.1.1.2.2. OUT 2

2.1.1.2.3. OUT 3

2.1.1.2.4. OUT 4

2.1.1.3. INPUTS

2.1.1.4. BATTERIES

2.1.1.4.1. BATTERY INFORMATION 1/4

2.1.1.4.2. BATTERY INFORMATION 2/4

2.1.1.4.3. BATTERY INFORMATION 3/4

2.1.1.4.4. BATTERY INFORMATION 4/4

2.1.1.5. LOG

2.1.1.5.1. FUNCTIONING TIME

2.1.1.5.2. TIME POWERED FROM POWER SUPPLY

2.1.1.5.3. TIME POWERED FROM BATTERY SUPPLY

2.1.1.5.4. NUMBER OF POWER SUPPLY FAILURES

2.1.1.5.5. NUMBER OF SL FAILURES (SENSE LOOP OPEN)

2.1.1.5.6. NUMBER OF TOTAL DISCHARGES

2.1.1.5.7. DURATION OF LAST AUTONOMY

2.1.1.5.8. DATE OF THE LAST FUNCTIONING TEST CARRIED OUT

2.1.1.5.9. DATE OF THE LAST DURATION TEST CARRIED OUT

2.1.1.5.10. POWER SUPPLY CONSUMED BY THE CENTRAL

2.1.1.5.11. RESET

2.1.2. CONTROLS

2.1.2.1. OUT 1

2.1.2.2. OUT 2

2.1.2.3. OUT 3

2.1.2.4. OUT 4

2.1.2.5. ALL

2.1.3. OPTIONS

2.1.3.1. OFF.BAT.DISCHARGED

2.1.3.2. MAKE TEST

2.1.3.2.1. FUNCTIONAL

2.1.3.2.2. DURATION

2.1.3.3. SOUND

2.1.4. CONFIGURATION

2.1.4.1. LANGUAGE

2.1.4.2. TIME

2.1.4.3. DATE

2.1.4.4. BUSING ID

2.1.4.5. INPUT ID

2.1.4.6. TIME, DATE AND INTERVAL OF FUNCTIONING TEST

2.1.4.7. TIME, DATE AND INTERVAL OF DURATION TEST

2.1.4.8. LED OUT1

2.1.4.8.1. ON

2.1.4.8.2. OFF

2.1.4.8.3. ON&FAIL

2.1.4.9. LED OUT2

2.1.4.9.1. ON

2.1.4.9.2. OFF

2.1.4.9.3. ON&FAIL

2.1.4.10. LED OUT3

2.1.4.10.1. ON

2.1.4.10.2. OFF

2.1.4.10.3. ON&FAIL

2.1.4.11. LED OUT4

2.1.4.11.1. ON

2.1.4.11.2. OFF

2.1.4.11.3. ON&FAIL

2.1.4.12. RELE AUX

2.1.4.13. PASSWORD

2.1.4.14. SELECTION OF VALUE FOR AUTONOMY CHECKING

2.1.4.15. SELECT THE BATTERY CAPACITY

2.1.4.16. INFO

2.1.4.17. SELF PROTECTION

2.1.4.18. WIZARD

2.1.5. TEST

3. ADDITIONAL INFO SCREEN 1/4 (Information about power supply for maintained option).

4. ADDITIONAL INFO SCREEN 2/4 (Information about the minimum programmed voltage to detect failures).



5. ADDITIONAL INFO SCREEN 3/4 (Time left for the next functioning test to be carried out).

6. ADDITIONAL INFO SCREEN 4/4 (Time left for the next duration test to be carried out).

9. MENU Screen

The MENU screen can be accessed by pressing the ACCEPT key in the main screen.

Use the up and down keys to browse in the menu. Select the desired option by pressing ACCEPT (the option that is selected will be shown by means of an arrow pointing at it in the right part of the text).

-  Up button.
-  Down button.
-  Accept button.

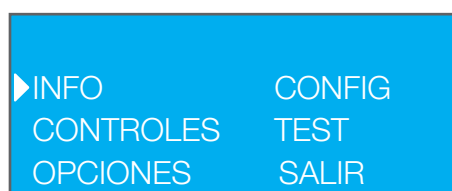

menu screen

There are 5 options within this menu:

- INFO: Provides information on the status of the central.
- CONTROLS: Access to the control and configuration of the outputs will be granted.
- OPTIONS: It access to some functioning features as well as the possibility of carrying tests out manually.
- CONFIG: It accesses several configuration options for the central.
- TEST: It carries out a functional test on the 4 outputs.
- EXIT: It exits the MENU screen to get back to the main screen.

10. INFO screen

Press INFO in the MENU screen to access this option.

The navigation method is the same as in the previous screen (by means of the up, down and accept buttons).

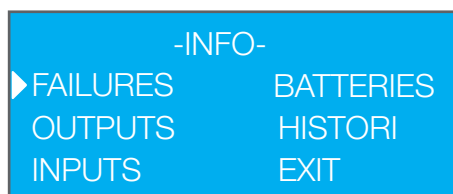

info screen

There are five options available in this menu:

- FAILURES: The possible failures in the central will be displayed here.

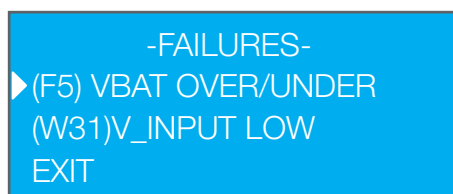

failure screen

Use the “Up” and “Down” buttons to move through the possible failures. To get detailed Info on a particular failure, just press “Accept” button when the failure has been selected. To exit, just press the “Accept” button again.

(F5) VBAT OVER/UNDER
Battery voltage outside of the nominal value.
Charge the unit for 24h.

failure screen

- **OUTPUTS:** Provides information about the status of the outputs.

-INFO-

▶ OUT1	OUT
OUT2	EXIT
OUT3	

outputs screen

Once one of the outputs has been selected, detailed information about its status will be displayed. Info about the actual status (MODE): On, off or fail.

Info on the current, output voltage and actual voltage consumed will be displayed as well. It will also inform about the minimum failure current programmed. This is the minimum current that the output should consume. If that value is 0, means that there will be no further minimum current comprobations.

-INFO OUT1-

MODE: ON

V: 24.0 V	P: 21.44 W
I: 0.89A	IF: 0.00 A

otuputs screen

- **INPUTS:** Information about the status of the inputs.

-INFO INPUTS-

LSS1:0	LSS4:0
LSS2:0	SL:1
LSS3:0	

inputs screen

This screen will show information about the status of the different inputs:

- » LSS1: 230Vac y 50Hz input, controlling the output n°1. If LSS1 is 1, means that Input n°1 has voltage. If it is 0 means there is no voltage.
- » LSS2: 230Vac y 50Hz input, controlling the output n°2. If LSS2 is 1, means that Input n°2 has voltage. If it is 0 means there is no voltage.
- » LSS3: 230Vac y 50Hz input, controlling the output n°3. If LSS3 is 1, means that Input n°3 has voltage. If it is 0 means there is no voltage.
- » LSS4: 230Vac y 50Hz input, controlling the output n°4. If LSS4 is 1, means that Input n°4 has voltage. If it is 0 means there is no voltage.
- » SL: SL: Input with internal Pull-Up. This input is used to supervise the emergency mode functioning. If the input is 1, it means that it has been jumpered, and if it is 0, it means it is open, therefore the central will enter the EMERG_EXT mode.

BATTERIES: Information about the status of the batteries.

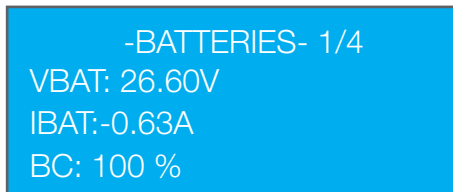

batteries screen 1

Info about the batteries is shown in 4 different screens. In the first one, the total voltage of the Pb battery group is informed, the actual charging and discharging current, as well as the percentage of charge of the batteries (being 100% means that the battery is fully charged).



batteries screen 2

The second screen informs about the individual voltage of each battery, as well as the value of the remaining capacity of the battery group. The value of the real capacity is calculated by carrying out a duration test. If there has been no test carried out, the value will show the theoretical capacity of the batteries installed.

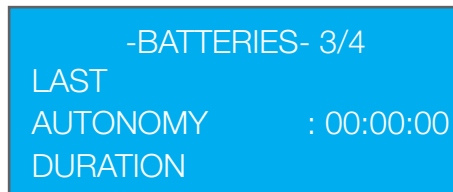

batteries screen 3

The third screen displays the result of the last duration test.

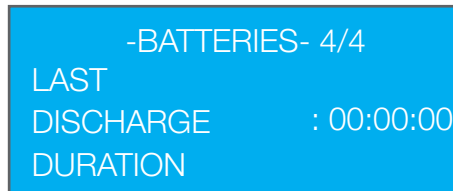

batteries screen 4

The last screen displays the result of the last battery discharge.

- LOG: The event log will show several different parameters related to the functioning of the central. It has eleven screens:
 - » Screen 1. Time that the central has been working.
 - » Screen 2. How long the power supply has been provided from mains.
 - » Screen 3. How long the power supply has been provided from the batteries.
 - » Screen 4. Number of times without power supply.
 - » Screen 5. Number of times the SL input has been open and the central has entered the EMERG_EXT mode.
 - » Screen 6. Number of full discharges of battery.

- » Screen 7. Duration of the last autonomy test.
- » Screen 8. Date and time when the last functioning test was carried out.
- » Screen 9. Date and time when the last autonomy test was carried out.
- » Screen 10. Total consumption since the device was connected.
- » Screen 11. It allows to erase the values of the last autonomy test, how long the power supply has been provided by the batteries, number of full discharges of the batteries and capacity.

Press ACCEPT to exit.

11. CONTROLS screen

It controls each output and enables the user to check each output's functioning mode.



controls screen

Once one output is selected, we can check if it is on or off. If it shows 0V, the output would be OFF. If it was on, a voltage of approximately 24v when feeded from the power supply and a voltage between 28-21v if it is receiving the power supply from the battery.

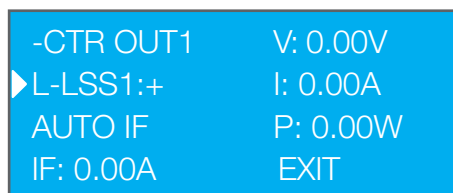

output control screen

Within the input control, there will be 3 options available:

- L-LSSx: Indicates the logic of functioning of the outputs regarding the inputs LSSx. If this option is positive (+), when LSSx input is 1, the X output will be activated. When LSS xis 0, output X will be deactivated.
- AUTO IF: Will automatically check which is the most appropriate value for the failure current for this output. The central will activate the output for a few seconds and will check the current output. Depending on this current, it will calculate the value of the appropriate current failure.
- IF: Within this paramenter, the failure current value can be manually chosen. If this value is 0, means that the failure current will not be checked.

12. OPTIONS screen

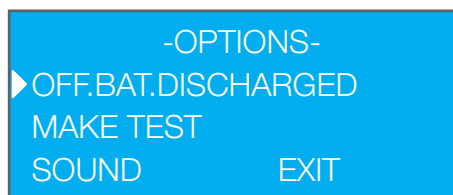

options screen

There are three options in this menu:

- OFF.BAT.DISCHARGED: Select this option to turn off the signal for the total battery discharged from the front panel.
- MAKE TEST: Enables the possibility of carrying out a functional or duration test manually.

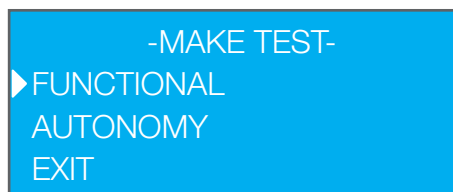

make test screen

By selecting FUNCTIONAL the central will carry out a functioning test in all the emergency fittings connected to it. When the test is done, there will be a failure screen displayed With all the incidences detected.

Selecting AUTONOMY, the central will make a duration test. All the inputs will be activated and the batteries will be fully discharged. While this test is being carried out, the time it has been downloaded, the current, the discharge voltage and the real capacity of the set of batteries will be displayed.

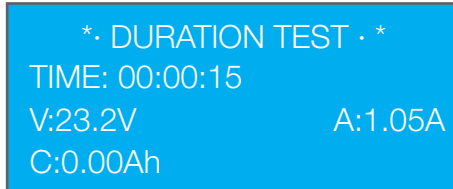

test progress screen

- SOUND: Makes it possible to activate or deactivate some sounds in the central.

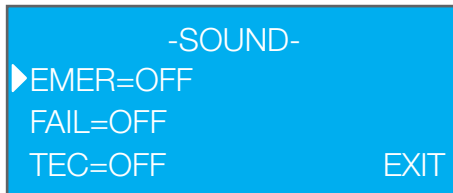

sound screen

There are three sounds that can be abled/disabled:

- » EMER: Makes it possible to able/disable a sound alarm when the fitting starts to be powered by a battery.
- » FAIL: Ables/disables a sound alarm when there is a new failure. After a new failure has happened, to silence an alarm it is only necessary to enter into the failures screen.
- » TEC: Activates a beep when pushing the buttons.

13. CONFIGURATION screen

The CONFIGURATION screen comprises sixteen options ordered in five screens:

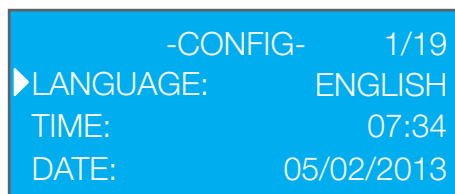

configuration screen 1

- TIME: Set the time of the central.*
- DATE: Set the date of the central.

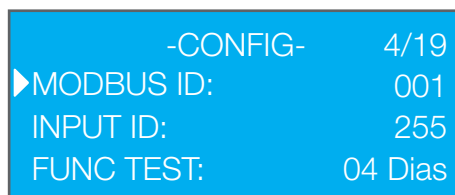

configuration screen 2

- MODBUS ID: Select the ID that the central will have in the domotic line. It is possible to assign this identification number automatically or manually.
- INPUT ID: Enables to establish the control of an input / output module with an ID.
- FUNC TEST: Makes it possible to set the day, the time and the interval when the functional test will be done. When this event is programmed, the first test will be carried out in the same week. After this, this will be carried out in the selected interval. The maximum interval that can be set is four weeks.

* Due to the precision of its components, this fitting may experience a slight delay on its internal clock. To keep the internal clock duly synchronized, a programming through Modbus is needed, by means of the FUNCTION (0x06) function. Please consult the instructions indicated in point 17 (page 30) of this document for more information. In the same way, the hour can be changed to adjust to the Winter / Summer times.

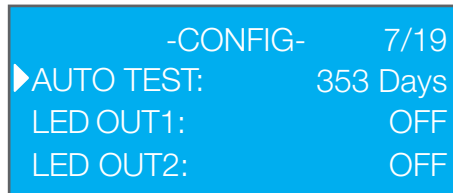

configuration screen 3

- TEST AUTO: Makes it possible to set the day, the time and the interval when the functional test will be carried out. The first test will be carried out once the selected interval has been finished. The maximum interval that can be set is 52 weeks.
- LED OUT 1: Makes it possible to set the status of the charge led of the luminaires connected to output 1.
 - » In ON the charge led of the luminaires will be switched on.
 - » In OFF, the led will be switched off.
 - » In ON&FAIL, the charge led will be switched on and will blink in case there is any failure in any of the luminaires connected.
- LED OUT 2: Makes it possible to set the status of the charge led of the luminaires connected to output 2.

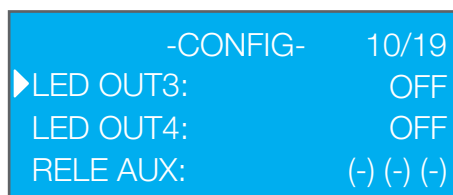

configuration screen 4

- LED OUT 3: Makes it possible to set the status of the charge led of the luminaires connected to output 3.
- LED OUT 4: Makes it possible to set the status of the charge led of the luminaires connected to output 4.
- Enables to establish the logic to be followed for the three potential free contact relays SYSTEM WORK, BATTERY SUPPLY and FAIL.

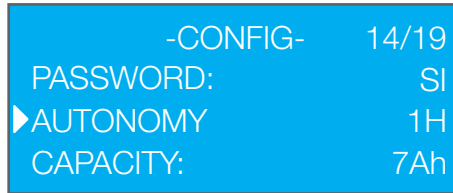

configuration screen 5

- **PASSWORD:** If this option is selected, it will be possible to include a password of five characters. Each of them can have three digits (1,2 and 3) corresponding to the buttons of the central. The default password is 22222.

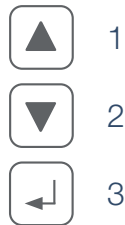

- **AUTONOMY:** We will select the autonomy that the fitting will check when carrying out the duration or autonomy test. If the duration of the test is less than the value set in this box, the central will show up an autonomy failure.
- **CAPACITY:** Selector of the capacity of the connected batteries.

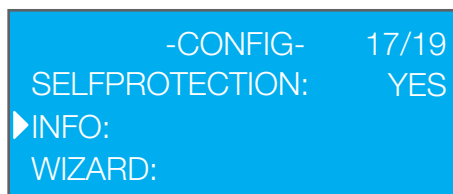

configuration screen 6

- **SELFPROTECTION:** Sets a protection over the central's power supply.
- **INFO:** Shows the information about the version of the central, manufacturing date and serial number.
- **WIZARD:** Launches the wizard for a fast configuration of the central.
- **EXIT:** We will be leaving the CONFIG screen and will go to the MAIN screen.

14. Calculation of the distances and wire sections

The calculations of the voltage drop in direct current and in the monophasic circuits in alternating current use the following equations:

$$(1) \quad CT = \frac{2L \cdot R_L \cdot I}{1000}$$

$$(2) \quad \%CT = \frac{100 \cdot CT}{V}$$

Where:

CT= = Voltage drop in V.

%CT= Percentage of voltage drop.

L= Length of the wire in meters.

R_L= Resistance in Direct Current at 25°C in Ohm/ Km

I= Current of the I wire in amperes.

V= Power supply in volts.

WIRE SECTION	MÁX. INTENSITY	DISTANCE*
1,5 mm ²	1 A	147
	2 A	74
	3 A	49
2,5 mm ²	1 A	245
	2 A	123
	3 A	82

* Distances for two-wires cable and charge at the end of line.

Example of the distributed charges.

Maximum wiring lengths depending on the section and the power supply.

This calculation has been done based on an uniform distribution of the fittings. The final distance corresponds to the point where the voltage drops under 3.5 V. Figures in brackets represent the distance between fittings, expressed in meters.

	1 A (13 VIALED)	2 A (25 VIALED)	3 A (38 VIALED)
1,5 mm ²	263 m (20,3 m)	142 m (5,7 m)	95 m (2,5 m)
2,5 mm ²	440 m (33,9 m)	237 m (9,5 m)	155 m (4,1 m)

Consumption VIALED = 0,08 A

15. Index of failures

FAILURE	TYPE	DESCRIPTION
F1	F_BAT1_DESCONECTADA	Battery 1 disconnected or fuse in battery 1 broken.
F2	F_BAT2_DESCONECTADA	Battery 2 disconnected or fuse in battery 1 broken.
F3	F_BAT1_DETERIORADA	Battery 1 worn out, power too low, or it is not getting any power.
F4	F_BAT2_DETERIORADA	Battery 2 worn out, power too low, or it is not getting any power.
F6	F_BAT1_CORTOCIRCUITO	Shortcut in Battery 1.
F7	F_BAT2_CORTOCIRCUITO	Shortcut in Battery 2.
F9	F_FUSIBLE_OUT1_BROKEN	Fuse in output 1 broken.
F10	F_FUSIBLE_OUT2_BROKEN	Fuse in output 2 broken.
F11	F_FUSIBLE_OUT3_BROKEN	Fuse in output 3 broken.
F12	F_FUSIBLE_OUT4_BROKEN	Fuse in output 4 broken.
F13	F_CAR_FAIL	Charger failure.
F14	F_OUT1_SHORTCIRCUIT	Output 1 in shortcut.
F15	F_OUT2_SHORTCIRCUIT	Output 2 in shortcut.
F16	F_OUT3_SHORTCIRCUIT	Output 3 in shortcut.
F17	F_OUT4_SHORTCIRCUIT	Output 4 in shortcut.
F18	F_CTRL_BUS_LED1	Failure in the control of the power for the switching on of the indicator leds (green led) in output 1.
F19	F_CTRL_BUS_LED2	Failure in the control of the power for the switching on of the indicator leds (green led) in output 2.
F20	F_CTRL_BUS_LED3	Failure in the control of the power for the switching on of the indicator leds (green led) in output 3.
F21	F_CTRL_BUS_LED4	Failure in the control of the power for the switching on of the indicator leds (green led) in output 4.
F23	F_AUTONOMIA	Autonomy failure.
F24	F24_OUT1_CTRL_OFF	Shows that the control circuit in Output 1 is unable to switch off the output. This could be happening because the relay that manages the output has undergone an important discharge through its contacts, and these might have been damaged. It could also be happening due to a failure in the control logic.
F25	F25_OUT2_CTRL_OFF	Shows that the control circuit in Output 2 is unable to switch off the output. This could be happening because the relay that manages the output has undergone an important discharge through its contacts, and these might have been damaged. It could also be happening due to a failure in the control logic.
F26	F26_OUT3_CTRL_OFF	Shows that the control circuit in Output 3 is unable to switch off the output. This could be happening because the relay that manages the output has undergone an important discharge through its contacts, and these might have been damaged. It could also be happening due to a failure in the control logic.
F27	F27_OUT4_CTRL_OFF	Shows that the control circuit in Output 4 is unable to switch off the output. This could be happening because the relay that manages the output has undergone an important discharge through its contacts, and these might have been damaged. It could also be happening due to a failure in the control logic.
F28	F28_REL1	Shows that there is a defect in Relay1 of power control.
F29	F29_REL2	Shows that there is a defect in Relay2 of power control.

15. Index of warnings

WARNING	TYPE	DESCRIPTION
W31	W_V_INPUT_LOW	24vdc input power too low (external source worn out?).
W32	W_IF_OUT1	Output 1 current is lower than the minimum current set.
W33	W_IF_OUT2	Output 2 current is lower than the minimum current set.
W34	W_IF_OUT3	Output 3 current is lower than the minimum current set.
W35	W_IF_OUT4	Output 4 current is lower than the minimum current set.
W36	W_BATERIA_VACIA	The battery has undergone a deep discharge and the screen shows the indicator of empty battery.
W37	W_IOUT_OUT_OFF_RANGE	
W38	W_OUT1_OFF_OVERCURRENT	Output 1 has been switched off as it exceeds the total power of the output and has its self-protection activated.
W39	W_OUT2_OFF_OVERCURRENT	Output 2 has been switched off as it exceeds the total power of the output and has its self-protection activated.
W40	W_OUT3_OFF_OVERCURRENT	Output 3 has been switched off as it exceeds the total power of the output and has its self-protection activated.
W41	W_OUT4_OFF_OVERCURRENT	Output 4 has been switched off as it exceeds the total power of the output and has its self-protection activated.
W42	W_OVERCURRENT	Maximum discharge current to comply with the duration has been exceeded.
W43	W43_OUT1_AUTOOFF	Shows that output 1 has been disconnected by self-protection.
W44	W44_OUT2_AUTOOFF	Shows that output 2 has been disconnected by self-protection.
W45	W45_OUT3_AUTOOFF	Shows that output 3 has been disconnected by self-protection.
W46	W46_OUT4_AUTOOFF	Shows that output 4 has been disconnected by self-protection.
W47	W47_POWER_VERY_HIGH	Shows that output power is above the permitted limit.

17. Modbus integration

Scan the QR code below to download the Modbus integration instructions of the central.



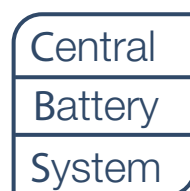

NormaGrup Technology, S.A.
Parque Tecnológico de Asturias.
Parcela 10
33428 Llanera (Asturias) · España
T. +34 985 267 100
F. +34 985 266 992
normagrup@normagrup.com
www.normagrup.com

NORMALUX
by Normagrup